

ASK4

STUDENT HOUSING

ENABLING SPECIFICATION

Fibre to the Home (FTTH) Infrastructure

Revision 2.2 (UK)

Client Generic

Project Generic

CONTENTS

Contents	2
Privacy Statement.....	3
Purpose.....	3
Disclaimer	3
Document Control	4
Change Control	4
Issue Register.....	4
About ASK4	5
Project Details	6
Project Team.....	6
Services Scope	6
Responsibilities Matrix	7
Installation	9
Pre-Installation Dates	10
Infrastructure Overview	11
Enabling Works.....	12
1. Infrastructure for Incoming Fibre.....	12
2. Infrastructure for Incoming Fixed Wireless Access	14
3. Main Comms Room.....	15
4. Building Data Connectivity Infrastructure.....	16
4.1. Regulation and Compliance	16
4.2. Main Comms Cabinet	16
4.3. Sub Comms Cabinets	17
4.4. Residential Comms Cabinets	17
4.5. Fibre-Optic Backbone Cabling	18
4.6. Fibre-Optic Horizontal Drop Cabling.....	19
4.7. Apartment Copper Data Cabling	20
4.8. Landlord Copper Data Cabling	21
4.9. Documentation.....	22
5. Power	23
Wireless Network	24
Landlord 3rd Party Building Systems	Error! Bookmark not defined.
Appendices	26
Appendix 1 – Example Telco Chamber	26
Appendix 2 – Labelling and Patch Panel Schedule Guide	27
Appendix 3 – Typical Data Point	31
Appendix 4 – Example Comms Cabinet Rack Layouts.....	32

Appendix 5 – Residential Comms Cabinets.....	35
Appendix 6 – Infrastructure Schematic for Elevator Wi-Fi	38

PRIVACY STATEMENT

PRIVATE AND CONFIDENTIAL

Copyright © 2024 ASK4 Limited (ASK4). All rights reserved. This document is strictly private and confidential. It is not to be copied or reproduced nor its contents disclosed in part or in whole to any other party without the prior written consent of ASK4.

The information contained within this document relates to a Commercial Interest in accordance with the definition of Section 43 of the Freedom of Information Act (2000) and must not be disclosed to third parties without the express written consent of ASK4 Limited as doing so may unfairly prejudice the Company’s fair commercial position.

PURPOSE

This document is a universal reference guide for design, standards, and best practice regarding the physical infrastructure requirements to be undertaken by the Developer in order to enable ASK4 to install and provide ASK4 services for the Client. It is intended that this document be used only in conjunction with consultation from an ASK4 Client Solution Engineer (CSE) and Project Management Office (PMO) and is, in any event, subject to site survey.

DISCLAIMER

References to the Developer within this document are generic and ASK4 understands that the works detailed in this document will be completed by various parties as part of the development of the site.

ASK4’s Client remains ultimately responsible to ASK4 for procuring that all works detailed in this document are completed.

ASK4 will not be liable for any costs or expenses incurred by the Developer or any third party in reliance upon the information contained in this document which (for the avoidance of doubt) is issued for general guidance only.

DOCUMENT CONTROL

CHANGE CONTROL

Revision	Date	Author	Change
1.0	28/11/2019	Ben Mawdsley	First specification for GPON services
2.0	31/01/2023	Matthew Prince	Enabling Specification updated for FTTH, compatibility with PON and AOF Added note regarding Openreach NIA service Added 7m or greater separation for incoming fibre ducts Added backbone fibre connection to the roof for FWA connectivity Updated main comms room size Updated copper data cabling specification, for compatibility with 10Gb (10GBASE-T) standards Added copper data cabling for elevator Wi-Fi coverage Added main comms room 32 amp power supply Updated BTU/Hr figures for main comms and sub comms Updated branding and layout
2.1	04/03/2024	Matthew Prince	Updated 'Documentation issued to ASK4' list
2.2	30/09/2024	Matthew Prince	Updated Responsibilities Matrix and Pre-Installation Dates sections with Third Party Services

ISSUE REGISTER

Issue Version	Date	Issued To	Issued By

ABOUT ASK4

Who are ASK4?

Internet connectivity and technology solutions at the heart of multi-tenant buildings internationally

Our team delivers connectivity and technology solutions to hundreds of thousands of users in multi-tenant buildings across three sectors including build-to-rent, student housing and later living, to help them live life and work productively.

Where do we operate?

ASK4 operates in 12 countries across the UK, Europe and the USA. We provide 24/7/365 multilingual support to the locations we serve to give our clients and customers the service they need, when they need it.

Headquartered in the UK, with offices in the USA, Spain and Germany, we are proud to support some of the world's leading providers of multi-tenant living and working spaces.

PROJECT DETAILS

ASK4 Site ID	Generic
ASK4 Project ID	Generic
Building Type	Student Housing
Building Connectivity Infrastructure	Fibre to the Home (FTTH)
Country	UK
Client	Generic
Project	Generic

PROJECT TEAM

Account Manager	[Choose an item]
Client Solution Engineer	[Choose an item]
Project Manager	[Choose an item]
Programme Manager	[Choose an item]

SERVICE REQUIREMENTS

Products and services to be delivered by ASK4 will be outlined in the Service Requirements Document (SRD) by the ASK4 Client Solution Engineer (CSE). The SRD requires Client approval prior to physical installation works taking place.

The ASK4 CSE must be notified of any changes, or new services required during the project delivery to ensure these are scoped, detailed in the SRD and approved by the Client.

ASK4 Project Management Office and Engineers will issue Information Capture forms for 3rd party systems in scope (e.g. CCTV, door access control) that require access to the ASK4 Open Services Network.

RESPONSIBILITIES MATRIX

	ASK4	ASK4 Appointed Telco	Developer
Documentation issued to ASK4			
Site General Arrangement (GA) drawings			●
Wall construction detail drawings (material composition)			●
Underground services drawings			●
Electrical/Low Voltage/Data drawings			●
Accommodation schedule			●
Accommodation/room numbered floor plans			●
Fibre-optic backbone cabling schematic (design)			●
Fibre-optic backbone cabling patch schedules and test certificates			●
Copper data cabling patch schedules and test certificates			●
Third Party Services OSN Information Capture form			●
Incoming Connectivity			
Site registration with Openreach New Sites (see 'Note regarding Openreach Infrastructure', Page 13)			●
Openreach FTTP DP installed within the main comms room			●
Procurement and delivery management of Incoming fibre services for ASK4 contracted services	●		
Openreach chamber and ducting route to the main comms room			●
Unbranded (Telco neutral) chamber and ducting route to the main comms room			●
ASK4 Incoming fibre street works (external of site)		●	
Installation of ASK4 incoming fibre, termination, and handover		●	
Infrastructure, conduit, containment, and cabling to the roof for fixed wireless access (FWA)			●
Main Comms Room			
Construction of dedicated main comms room			●
Active cooling / air conditioning			●
Main comms cabinet			●
Power supplies and cabinet PDU bar(s)			●
Sub Comms Cabinets			
Provision of space for sub comms cabinets			●
Passive, active cooling / air conditioning			●
Sub comms cabinets			●
Power supply and cabinet PDU bar(s)			●
Residential Comms Cabinets			
Provision of space for resident comms cabinets			●
Residential comms cabinets			●
Power supply			●

	ASK4	ASK4 Appointed Telco	Developer
Fibre-Optic Backbone Cabling			
Backbone cabling design			●
Conduit and containment for backbone cabling			●
Backbone fibre-optic cabling, supply and install			●
Termination, testing and labelling of backbone cabling			●
Installation compliance with relevant standards and regulations			●
Fibre-Optic Horizontal Drop Cabling			
Horizontal drop cabling design			●
Conduit and containment for horizontal drop cabling			●
Horizontal drop cabling supply and install			●
Termination, testing and labelling of horizontal drop cabling			●
Installation compliance with relevant standards and regulations			●
Resident Copper Data Cabling			
Copper data cabling design			●
Conduit and containment for copper data cabling			●
Copper data cabling, supply and install			●
Termination, testing and labelling of copper data cabling			●
Installation compliance with relevant standards and regulations			●
Landlord Copper Data Cabling			
Copper data cabling design			●
Conduit and containment for copper data cabling			●
Copper data cabling, supply and install			●
Termination, testing and labelling of copper data cabling			●
Installation compliance with relevant standards and regulations			●
Active Network Equipment (for ASK4 contracted services)			
Wi-Fi network design, and access point locations	●		
Supply and installation of Wi-Fi access points	●		
Supply and installation of active network equipment, switching and routing equipment	●		
Configuration, commissioning and quality assurance testing of active network equipment and Wi-Fi services	●		
Network equipment support and maintenance	●		

INSTALLATION

The contract for Managed Internet Services between the Client and ASK4 sets out a specific Pre-Installation Date and Installation Dates.

The Installation Date is the date by which time the Client requires all ASK4's active equipment to be installed, fully commissioned and ready for use. It may or may not coincide with the building PC date. The Pre-Installation Dates are the dates by which the Client/Developer need to have ASK4's enabling works completed. There are two specific Pre-Installation Dates, one is set at four months prior to the Installation Dates and the other at two months prior to the Installation Dates. The enabling works required by each date are set out in the Pre-Installation Dates schedule below.

For example, if the Installation Dates in the contract is 1st September (in any given year), the 4 month Pre-Installation Date will be 1st May and the 2 month Pre-Installation Date will be 1st July.

The Client/Developer must complete the Pre-Installation Date enabling works in order that the contractually agreed Installation Date can be met by ASK4.

ASK4 Project Management Office (PMO) and Field Engineers (FE) will co-ordinate survey and installation visits and access requirements.

Any delay to the enabling works or changes to the agreed Installation Date must be notified to the ASK4 PMO.

PRE-INSTALLATION DATES









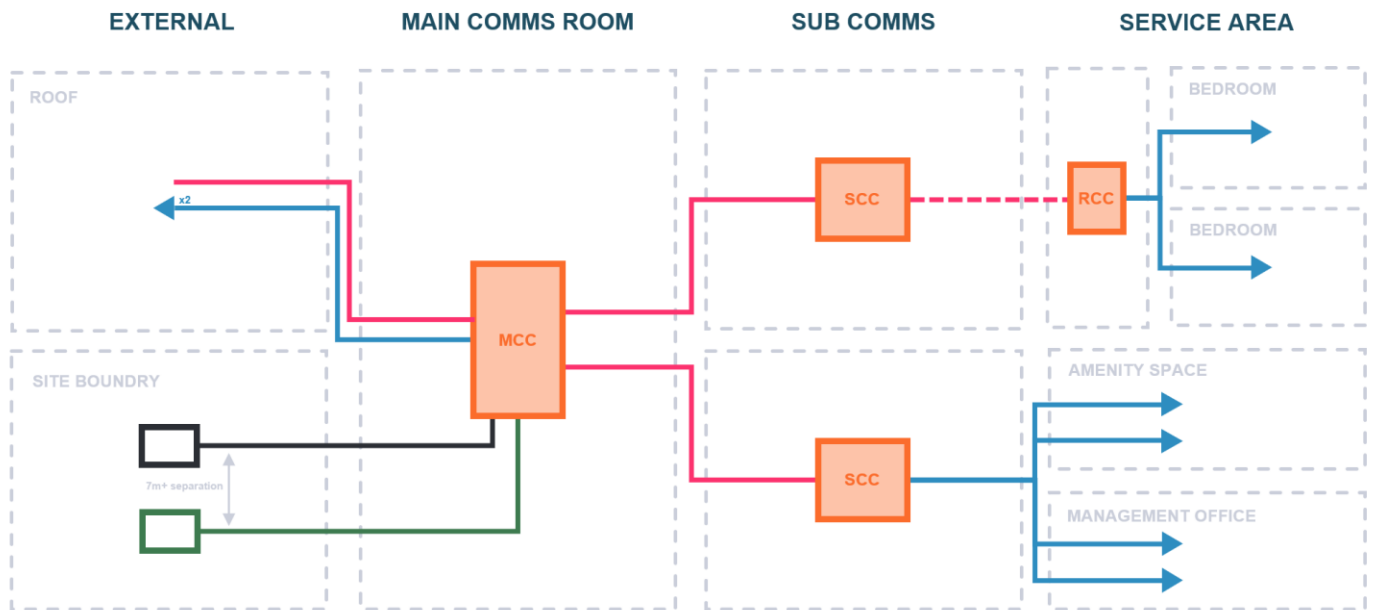

The Developer enabling works must be completed by the contractually agreed Pre-installation date for the contractually agreed Installation Date to be met. The ASK4 PMO must be notified of any delay to the enabling works or changes to the agreed Installation Date.

Project Initiation	Meeting / Site Visit
Documentation issued to ASK4 <ul style="list-style-type: none"> • Site General Arrangement (GA) drawings • Wall construction detail drawings (material composition) • Underground services drawings • Electrical/Low Voltage/Data drawings • Accommodation schedule • Accommodation/room numbered floor plans • Fibre-optic cabling schematic (design) 	ASK4 project kick off, scope and design meeting
Site registration with Openreach New Sites (see 'Note regarding Openreach Infrastructure', Page 13)	
Service Requirements and Third Party Service scope agreed	
Four months prior to Installation Date	Meeting / Site Visit
Main comms room is fully constructed and capable of being secured	
Main comms cabinet installed	
Openreach chamber and ducting route to the main comms room	ASK4 Field Engineer Pre-installation site survey
Unbranded (Telco neutral) chamber and ducting route to the main comms room	
Boundary access chamber locations clear and accessible for Telco external civils works	
Two months prior to Installation Date	Meeting / Site Visit
Infrastructure, conduit, containment, and cabling to the roof for fixed wireless access installed	
Main comms room active cooling / air conditioning installed	
Main comms room power supplies and cabinet PDU bar(s) installed	
Sub comms cabinets installed	
Sub comms passive, active cooling / air conditioning installed	
Sub comms power supply and cabinet PDU bar(s) installed	
Residential comms cabinets installed	
Residential comms power supply	ASK4 Field Engineer Pre-installation site survey
Fibre-optic backbone cabling installed, terminated, tested, and labelled	
Fibre-optic horizontal drop cabling installed, terminated, tested, and labelled	
Copper data cabling installed, terminated, tested, and labelled	
Fibre-optic backbone cabling patch schedules and test certificates issued to ASK4	
Fibre-optic horizontal drop cabling patch schedules and test certificates issued to ASK4	
Copper data cabling patch schedules and test certificates issued to ASK4	
Third Party Services OSN Information Capture form completed and issued to ASK4 for each Third Party Service	

INFRASTRUCTURE OVERVIEW

The diagram below provides an example high-level overview of the infrastructure requirements, further detail is provided in this document. Physically separate blocks of the same site must be incorporated into the fibre-optic backbone.



Key	Description
 	A - Infrastructure for incoming fibre
 	B - Infrastructure for incoming fibre
	Main comms cabinet (MCC)
	Sub comms cabinet (SCC)
	Residential comms cabinet (RCC)
	Fibre-optic backbone cabling
	Fibre-optic horizontal drop cabling
	Copper data cabling
	RJ45 data outlet

ENABLING WORKS

1. INFRASTRUCTURE FOR INCOMING FIBRE

Multiple and diverse infrastructure must be provided for incoming fibre connectivity between the site boundary and the main comms room, with 7m or greater separation for diversity.

The site boundary chambers and external areas must be kept clear for access by ASK4's appointed Telco Service Provider for survey, external civils, installation, and commissioning of the incoming fibre connectivity. External and internal containment must be fully accessible during and post construction for installation and maintenance of the incoming fibre connectivity.

Requirements

A

Openreach Infrastructure

- Site registration with Openreach New Sites (see' Note regarding Openreach Infrastructure', Page 13)
 - Openreach chamber must be provided at the site boundary
 - The chamber must be constructed from Openreach free-issue materials and built to Openreach specification
 - A continuous duct route must be provided from the Openreach site boundary chamber to the main comms room
 - The duct must be constructed from Openreach free-issue materials, and built to Openreach specification
-

B

Unbranded (Telco neutral) Infrastructure

- Must be constructed from unbranded materials
 - A private chamber must be provided at the site boundary
 - This chamber is for the dedicated use of ASK4's nominated Telco fibre provider
 - Minimum dimensions must be either of the following 2 types
 - Length: 915mm width: 445mm depth: 900mm
 - Length: 1310mm width: 610mm depth: 1200mm
 - Chamber base must be 150mm concrete base and must be clean and level
 - Duct entries must not enter through corners and must be no less than 75mm from the side wall
 - Duct to enter wall with 350mm minimum depth from top of frame and cut flush
 - Duct to clear base by 100mm minimum
 - Frame and cover frame to be set on a mortar bed and fitted squarely to box structure
 - Chamber cover must use lifting key no.5
 - A continuous duct route must be provided from the unbranded / private chamber to the main comms room
 - 100mm duct shall be used and have slow radius bends - minimum bend radius: 300mm
 - Duct must be dedicated for data services and not used to carry any other services into the building
 - Duct to contain drawstrings and must be kept clean and clear of debris at all stages of construction
 - Duct must be constructed from suitable materials with a minimum cover depth of 450mm
 - Once within the main comms room the ducting must link to tray work that presents immediately above or below the main comms cabinet
-

Note regarding Openreach Infrastructure

Regardless of which Telco service provider ASK4 select to provide the main incoming fibre into the building, the site will need to be registered, by the Client/Developer with Openreach New Sites. In addition, ASK4 advises that the Client/Developer should consider Openreach Network in Advance (NIA) services.

This is where Openreach will carry out the off-site works required to bring a connection from the telephone exchange to the boundary of the new site, in advance of a connection being ordered and therefore avoiding potential delays with planning permissions, permits, etc in the surrounding streets.

If ASK4 then order the main incoming fibre via a Telco provider that works with Openreach, or the Client or Developer order a Fibre to the Premises (FTTP) service for telephone, lift line or Redcare services, it means that much of the work to get the connection to the site boundary will have already been done by Openreach's NIA service.

2. INFRASTRUCTURE FOR INCOMING FIXED WIRELESS ACCESS

Containment and cabling must be provided from the main comms room to the highest accessible roof via a swan neck roof penetration.

The containment must be fully accessible during and post construction for installation and maintenance of incoming fixed wireless access (FWA).

Data Cabling Requirements

- 1 x 4-core single-mode OS2 (9/125) fibre-optic cable between the roof and the main comms room
- 2 x external grade Catogery6A (CAT6A) cables between the roof and the main comms room
- All cables must be terminated within a weatherproof enclosure on the roof, terminated upon a patch panel at the main comms room and must be tested and labelled

If the cabling distance between the main comms room and the roof exceeds 90m the cabling should be taken back to the nearest sub comms cabinet.

3. MAIN COMMS ROOM

The main comms room must be dedicated for Telecommunications and ASK4 equipment.

The room dimensions and layout must allow for working space around the main comms cabinet(s) of 1200mm (front), 1200mm (rear), and 900mm (one side).

Recommended room dimensions of 3200mm x 2500mm (for up to 2 floor standing comms cabinets).

Minimum room dimensions of 3200mm x 1700mm (for up to 1 floor standing comms cabinet).

Minimum room ceiling height of 2200mm.

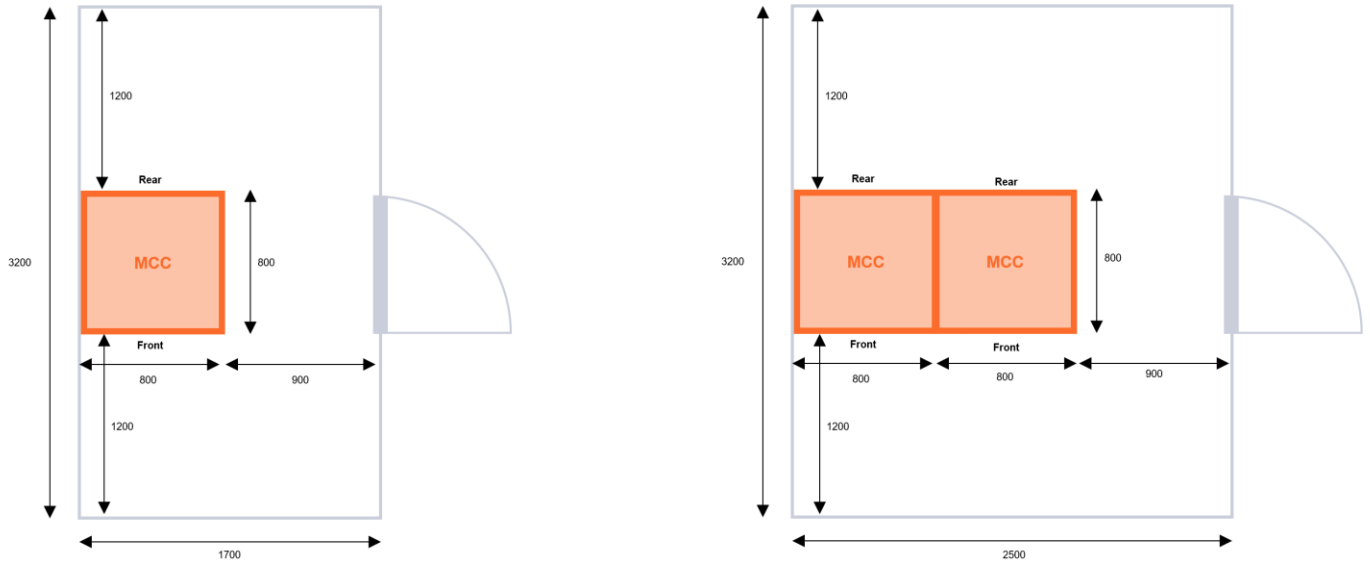

The Developer must ensure walls and ceilings are sealed or painted with a hardwearing anti-static floor covering and the room must be debris, dust/particle free. There must be no overhead water or waste services in the main comms room.

Active cooling or air conditioning must be provided in the main comms room. The air conditioning unit must have sufficient cooling to maintain the room temperature between 18°C and 24°C with a heat dissipation from ASK4 equipment of 3000 BTU/Hr + 500BTU/Hr for every patch panel (fibre and copper) terminated within the main comms room.

The Developer must ensure the main comms room has a permanent door with integral lock and should be secure at all times. Access to be restricted to authorised personnel for maintenance purposes only.

IMPORTANT: ASK4 reserve the right to power off equipment and/or delay their installation of equipment until the active cooling / air conditioning has been commissioned and is running live. Equipment installed by ASK4 in the main comms room will not be warranted unless active cooling / air conditioning is installed and maintained in working order.

4. BUILDING DATA CONNECTIVITY INFRASTRUCTURE

4.1. REGULATION AND COMPLIANCE

The building data connectivity infrastructure must be installed in accordance with the relevant standards and regulations, and the data cabling manufacturers specification.

Including but not limited to:

BS 6701: 2016 + A1:2017	Telecommunications equipment and telecommunications cabling – Specification for installation, operation and maintenance
BS EN 50173-1: 2018	Information technology. Generic cabling systems. General requirements
BS EN 50173-2: 2018	Information technology. Generic cabling systems. Office premises
BS EN 50173-6: 2018	Information technology – Generic cabling – Distributed Building Services
BS EN 50174-1: 2018	Information technology – Cabling installations – Specification and quality assurance
BS EN 50174-2: 2018	Information technology – Cabling installations – Installation and planning and practices inside buildings.
BS EN 50174-3:2018	Information technology – Cabling installations – Installation and planning and practices outside buildings
BS EN 50310	Telecommunications bonding networks for buildings and other structures
BS EN 50575: 2014 +A1:2016	Power, Control and Communication Cables – Cables for general applications in construction works subject to reaction to fire
BS EN 50346	Information technology – Cabling installations – Testing of installed cabling
BS7671	IET Electrical Wiring Regulations – current version

4.2. MAIN COMMS CABINET

The main comms cabinet (MCC), located within the main comms room must be a floor standing, 42u (height), 800mm (width) 800 (depth) and the cabinet must have front and rear mounting rails.

If there are more than 8 patch panels terminating within the main comms room, a second cabinet must be provided.

Working space around the MCC(s) of 1200mm (front), 1200mm (rear), and 900mm (one side) must be provided. If there are more than two cabinets, they can be located side-by-side.

The MCC shall not be adopted by other services without the prior written agreement of ASK4.

The MCC must be earthed in accordance with the relevant standards and regulations, and the manufacturers specification.

4.3. SUB COMMS CABINETS

Sub comms cabinets (SCC) must be provided, typically one per block, or by floor distribution depending on the site layout. The SCC's should be located within a secure landlord accessible area(s) of the building (not within a flat or apartment), either in a dedicated room, telecommunications riser or shaft, or other suitable location.

The SCC must be floor or wall mounted, 500mm (width) 500 (depth) height as required shown in the table below. Wall mounted SCC must be installed no higher than 2m to the top of the cabinet.

Number of patch panels (fibre and copper)	Minimum sub comms rack units (height in U)
1-2	9u
3	12u
4-5	18u
5-6	21u
7-8	24u
9-10	29u
11-14	42u

The Developer must ensure wall and ceilings are sealed or painted, and the location must be debris and dust/particle free.

The Developer must provide suitable active cooling or passive ventilation to maintain the sub comms location temperature below 24°C with a heat dissipation from ASK4 equipment of 500BTU/Hr for every patch panel (fibre and copper) within the sub comms room.

The SCC must not be adopted by other services without the prior written agreement of ASK4.

The SCC must be earthed in accordance with the relevant standards and regulations, and the manufacturers specification.

4.4. RESIDENTIAL COMMS CABINETS

Residential comms cabinets (RCC) must be installed for every 4 resident service area data outlets. The RCC must be located within a landlord accessible area or shared area of a cluster flat and be wall mounted no higher than 2m to the top of the cabinet.

Within the RCC vertical mounting space of 350mm (width), 350mm (height), 25mm (depth) must be reserved for ASK4's active equipment.

For an example list of RCC products, please see Appendix 5.

4.5. FIBRE-OPTIC BACKBONE CABLING

Single-mode OS2 (9/125) fibre-optic backbone cabling must be provided between main comms cabinet (MCC) and each sub comms cabinet (SCC) in a star topology emanating from the main comms cabinet.

The fibre-optic backbone cabling must be terminated by fusion splicing upon fibre-optic patch panels with **SC/APC** connectors. For every 1U fibre-optic patch panel 1U cable management bar must be installed. Single-mode OS2 (9/125) cabling must be used for all backbone links with the fibre core count as below.

Number of horizontal drop cables	Number backbone fibre cores
32	12 cores
64	12 cores
96	12 cores
128	12 cores
160	14 cores
192	16 cores
224	18 cores
256	20 cores
288	22 cores
320	24 cores

All fibre-optic cabling must be installed in dedicated, sufficiently sized containment throughout the cable run in accordance with the relevant standards and regulations, and the data cabling manufacturers specification. Vertical riser containment must be a minimum of 150mm.

Physically separate blocks of the same development must be incorporated into the fibre-optic backbone.

All fibre-optic backbone cabling must be tested and support standards including IEEE 1000BASE-LX, 10GBASE-LR, 25GBASE-LR, 100GBASE-FR1, ITU-T G.984 and G.987 using a tester, or test equipment approved by the fibre-optic cabling manufacturer and in accordance with relevant cabling regulations and standards. Fibre-optic cabling test results must be issued to ASK4 prior to the installation of ASK4's active equipment.

Fibre-optic backbone cabling must be labelled on the patch panel at each end identifying the near-end (source) and far-end (destination) rack, patch panel and fibre cores. The 'patch panel schedule' must include the near-end and far-end rack, patch panel, core/port, fibre-optic cable type, cable length and connector type. See Appendix 2 for an example 'patch panel schedule' template.

4.6. FIBRE-OPTIC HORIZONTAL DROP CABLING

Single-mode OS2 (9/125) 4-core fibre-optic horizontal drop cabling must be provided between each resident comms cabinet (RCC), and the nearest sub comms cabinet (SCC).

All 4 cores of the fibre-optic horizontal drop cabling must be terminated by fusion splicing upon a fibre-optic customer splice point or patch panel within the RCC, and patch panel at the SCC. **SC/APC** connectors must be used for all fibre terminations. For every two 2 fibre-optic patch panels 1U cable management bar must be installed within the SCC.

All fibre-optic cabling must be installed in suitable containment throughout the cable run in accordance with the relevant standards and regulations, and the data cabling manufacturers specification.

All fibre-optic horizontal drop cabling must be tested and support standards including IEEE 1000BASE-LX, 10GBASE-LR, 25GBASE-LR, 100GBASE-FR1, ITU-T G.984 and G.987 using a tester, or test equipment approved by the fibre-optic cabling manufacturer and in accordance with relevant cabling regulations and standards. Fibre-optic cabling test results must be issued to ASK4 prior to the installation of ASK4's active equipment.

Fibre-optic horizontal drop cabling must be labelled at each end identifying the near-end (source) and far-end (destination) cabinet, patch panel, apartment, and fibre cores. The 'patch panel schedule' must include the near-end and far-end cabinet, patch panel, apartment and fibre cores, fibre-optic cable type, cable length and connector type. See Appendix 2 for an example 'patch panel schedule' template.

4.7. APARTMENT COPPER DATA CABLING

Copper data cabling must be provided throughout all resident accommodation and living areas, the cabling must be of **Catogery6 (CAT6), up to 45m** or **Catogery6A (CAT6A), up to 90m**, capable of delivering 10GBASE-T Ethernet connectivity. All apartment copper data cabling must be terminated, tested, and labelled by the Developer.

	Quantity	Cabling Presentation
Bedroom study desk	1	<ul style="list-style-type: none"> • Single RJ45 socket at each study desk location • 40 to 60mm deep recessed back box/mounting box • 100mm clearance all around the socket - see Appendix 3
Television point	1	<ul style="list-style-type: none"> • Single RJ45 socket at each TV position • 40 to 60mm deep recessed back box/mounting box • 100mm clearance all around the socket - see Appendix 3
Shared lounge / kitchen	1	<ul style="list-style-type: none"> • Single RJ45 socket low level within each shared lounge/kitchen • 40 to 60mm deep recessed back box/mounting box • 100mm clearance all around the socket - see Appendix 3
Wi-Fi (Ceiling mounted locations, as required, to ASK4 specified location)	1 per Wi-Fi AP	<ul style="list-style-type: none"> • Cable with field terminated RJ45 plug within 500mm of ASK4 specified location • Presented below the ceiling through suitable hole, with 100mm of cable that can be pushed back into the ceiling void

All resident copper data cabling must emanate from the local resident comms cabinet (RCC), terminated upon RJ45 quad plate, or patch panel. The cable distance between the RCC and data point must not exceed 45m for CAT6 and 90m for CAT6A. Quad plate / patch panels and cabling data points must be terminated in accordance with standard TIA/EIA-568-B.

All resident copper data cabling must be installed in suitable containment throughout the cable run in accordance with the relevant standards and regulations, and the cabling manufacturers specification.

All resident copper data must be tested and certified for IEEE 802.3ab (1000BASE-T), IEEE 802.3bz (2.5/5GBASE-T) IEEE 802.3an (10GBASE-T) data transmission and IEEE 802.3af, 802.3at and 802.3bt Power over Ethernet (PoE) standards using a tester approved by the data cabling manufacturer and in accordance with relevant cabling regulations and standards.

Copper data cabling test results must be issued to ASK4 prior to the installation of ASK4's active equipment.

All resident copper data cabling must be labelled at the quad plate / patch panel with the corresponding data point identification. The labelling/identification scheme must be provided on a 'patch panel schedule' including data point locations and purpose. See Appendix 2 for an example 'patch panel schedule' template.

4.8. LANDLORD COPPER DATA CABLING

Copper data cabling must be provided for services throughout landlord, communal and back of house areas. The cabling must be of **Catogery6 (CAT6), up to 45m** or **Catogery6A (CAT6A), up to 90m** and capable of delivering 10GBASE-T Ethernet connectivity. All landlord copper data cabling must be terminated, tested, and labelled by the Developer.

	Quantity	Cabling Presentation
Wi-Fi (Ceiling mounted locations, as required, to ASK4 specified location)	1 per Wi-Fi AP	<u>Plasterboard Ceiling</u> <ul style="list-style-type: none"> • Cable with field terminated RJ45 plug • Presented below the ceiling through suitable hole, with 100mm of cable that can be pushed back into the ceiling void <u>Solid / Exposed Ceiling</u> <ul style="list-style-type: none"> • Single RJ45 socket, mounted on the ceiling, or cable • 40 to 60mm deep surface mounted back box/mounting box <u>Ceiling Tiles (Lay-in Grid)</u> <ul style="list-style-type: none"> • Single RJ45 socket, mounted above the ceiling • 40 to 60mm deep surface mounted back box/mounting box
Outdoor Wi-Fi (Wall mounted locations, as required, to ASK4 specified location)	1 per Wi-Fi AP	<ul style="list-style-type: none"> • Single RJ45 socket installed within a weather resistant box • The weather resistant box must include an available cable gland to connect a patch lead to the external Wi-Fi AP
Elevator Wi-Fi	1 per Elevator car	<ul style="list-style-type: none"> • Single RJ45 socket mounted within each elevator car for the provision of a Wi-Fi
Reception & Management Office	4 per desk space	<ul style="list-style-type: none"> • Quad RJ45 socket to each desk location
General (Client specified)	As required	<ul style="list-style-type: none"> • As required by the Client for landlord services and 3rd party systems
Incoming FWA	2	<ul style="list-style-type: none"> • Dual RJ45 socket installed within a weather resistant box on the highest accessible roof

All landlord copper data cabling must emanate from sub comms cabinets (SCC) terminated upon RJ45 patch panels. For every 2U of copper patch panels 1U cable management bar must be installed. The cable distance between the SCC and data point must not exceed 45m for CAT6 and 90m for CAT6A. Patch panels and cabling data points must be terminated in accordance with standard TIA/EIA-568-B.

External grade cabling must be used for all outdoor Wi-Fi access points, and any 3rd party external services.

All landlord copper data cabling must be installed in suitable containment throughout the cable run in accordance with the relevant standards and regulations, and the cabling manufacturers specification.

All landlord copper data must be tested and certified for IEEE 802.3ab (1000BASE-T), IEEE 802.3bz (2.5/5GBASE-T) IEEE 802.3an (10GBASE-T) data transmission and IEEE 802.3af, 802.3at and 802.3bt Power over Ethernet (PoE) standards using a tester approved by the data cabling manufacturer and in accordance with relevant cabling regulations and standards. Copper data cabling test results must be issued to ASK4 prior to the installation of ASK4's active equipment.

Landlord copper data cabling must be labelled at Sub Comms Cabinet (SCC) patch panel and data point with the corresponding data point identification. The labelling/identification scheme must be provided on a 'patch panel schedule' including cabinet, patch panel, port, connector, floor, service area, purpose, cable type and cable length. See Appendix 2 for an example patch panel schedule template.

4.9. DOCUMENTATION

The Developer must supply documentation for all building data connectivity infrastructure for the dates set out in the **Pre-Installation Dates** section of this document, including but not limited to:

- Electrical/Low Voltage/Data drawing
- Fibre-optic cabling schematic (design)
- Fibre-optic backbone cabling patch panel schedules
- Fibre-optic backbone and test certificates
- Fibre-optic horizontal drop cabling patch panel schedules
- Fibre-optic horizontal drop cabling test certificates
- Copper data cabling patch panel schedules
- Copper data cabling test certificates

IMPORTANT: Fibre-optic and copper data cabling patch panel schedules and test certificates must be issued to ASK4 prior to installation of ASK4's active network equipment. Failure to provide this documentation may cause delay to the installation and commissioning of ASK4 services.

5. POWER

Dedicated power supplies must be provided for each main comms cabinet and sub comms cabinets from the landlord power distribution. Dedicated sockets must be provided for the resident comms cabinet as detailed in the table below.

Location	Power Supplies	PDU
Main comms cabinet	2 x 16 amp commando sockets per cabinet, mounted above the cabinet	1 x PDU per cabinet, with 12 13 amp BS 1363 sockets
	1 x 32 amp commando sockets per cabinet, mounted above the cabinet	NA
Sub comms Cabinet	2 x 16 amp commando sockets per cabinet, mounted above the cabinet	1 x PDU per cabinet, see table below for number of power sockets required
Resident comms cabinet	2 x 13 amp sockets adjacent to the cabinet	NA

Sub comms cabinet PDU bar socket requirements:

No. of data cables	13 amp BS 1363 sockets required on the PDU
0 – 99	8
100 – 199	10
200 – 299	12
300 – 399	13

All data cabinets must be earthed in accordance with the relevant standards and regulations, and the manufacturers specification.

WIRELESS NETWORK

ASK4's Design Team will design and plan the Wi-Fi access point locations to meet the service level and coverage required by the Client and end users, as detailed in the Service Requirements Document (SRD). ASK4 will implement a range of access point types including wall plate, ceiling mounted and external units. The AP type will vary between projects depending on the site construction and client requirements.

AP Type	Typical Installation
Wall plate AP	Typically installed into bedrooms, studios, apartment living room / kitchens utilising the data socket in these locations already installed by the Developer.
	Wall plate access points provide a pass-through port for wired connectivity.
	Fixing directly over the recessed back box/mounting box, 100mm clearance is required all around the single RJ45 socket in these locations to accommodate wall plate access points - see Appendix 3.
Ceiling AP	Typically installed on the ceiling in apartment living room / kitchens, and throughout landlord amenity and common areas, to ASK4 specified locations.
	ASK4's Design team will issue marked up plans showing ceiling mounted access point locations for cabling installation by the Developer. Data cables must be installed within 500mm of the ASK4 specified locations.
External AP	Typically installed in outdoor amenity areas, and resident accessible roof terraces, to ASK4 specified locations.
	ASK4's Design team will issue marked up plans showing external access point locations for cabling installation by the Developer. Data cables should be installed at a height of 3.5m to ASK4 specified locations.

IMPORTANT: Any proposed variation to the ASK4 specified wireless access point locations exceeding 500mm must be agreed in writing with ASK4.

THIRD PARTY SERVICES

ASK4's Open Service Network (OSN) allows for the easy integration of smart technologies, landlord services and 3rd party building management systems within multi-tenant buildings.

All third-party services that require Internet connectivity from ASK4 **must** be specified and agreed with ASK4, in the ASK4 Service Requirements Document (SRD). Any third-party services not specified are excluded.

Example landlord services and 3rd party building management systems:

- Access control
- IP CCTV
- Laundry monitoring
- Combined heat & power systems
- Building management systems
- Digital signage
- Smart TV / Internet enabled TVs (Internet access only)
- Gym equipment
- AV equipment
- Vending machines
- Internet of Things (IoT) devices

The ASK4 OSN Information Capture Form must be completed for each service or system that requires connectivity, this form must be returned to the ASK4 Project Management Office.

IMPORTANT: Copper data cabling requirements for landlord services and 3rd party building management systems must be specified, and provided by the Developer, and is outside the scope of ASK4's Enabling Specification. The Developer is responsible for service area and terminal equipment patching for landlord services and 3rd party building management systems. ASK4 are responsible for patching main comms, and sub comms connections between the patch panel and ASK4 supplied active network equipment following the 'patch panel schedule' provided by the Developer.

APPENDICES

APPENDIX 1 – EXAMPLE TELCO CHAMBER

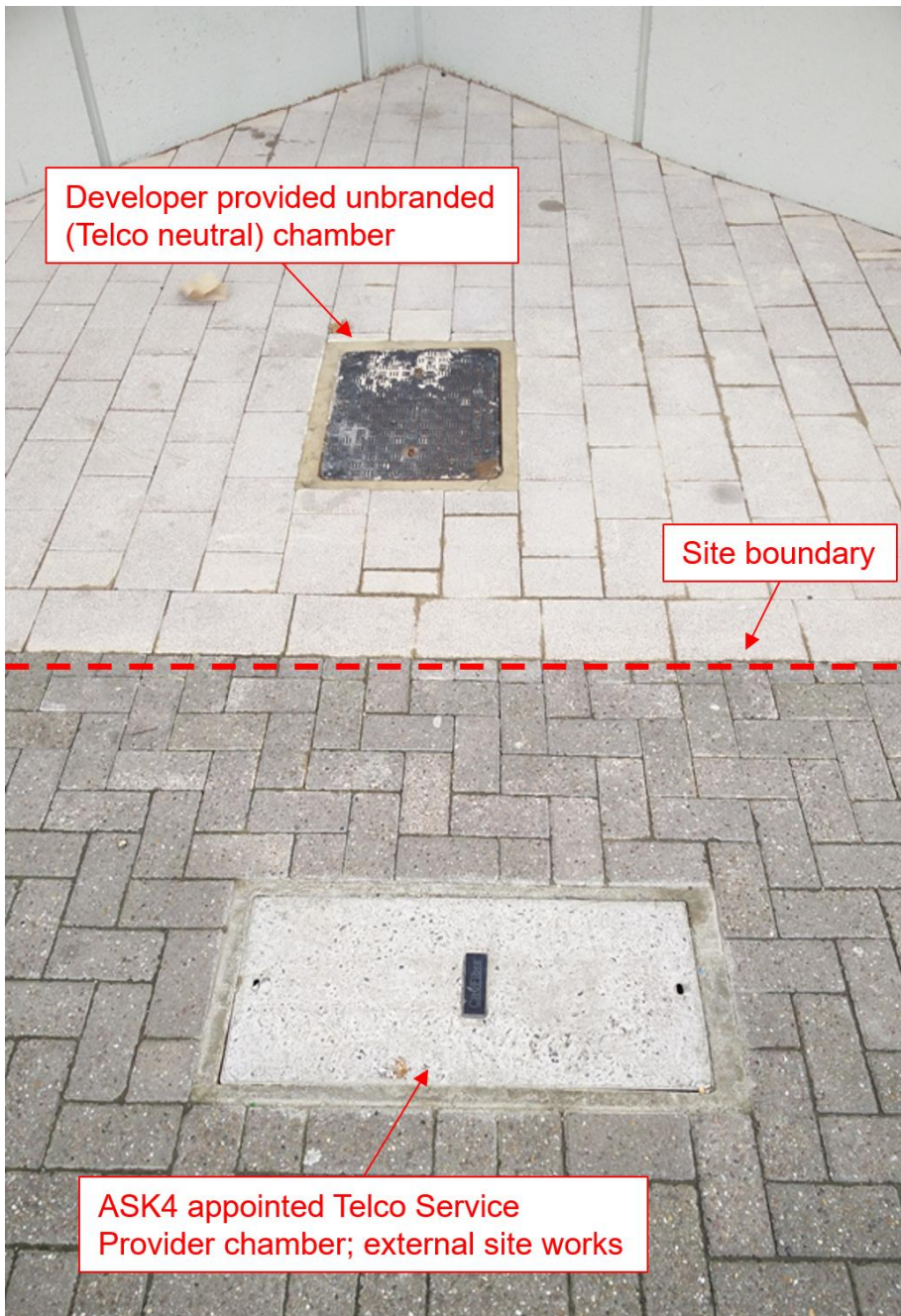

APPENDIX 2 – LABELLING AND PATCH PANEL SCHEDULE GUIDE

Fibre-Optic Backbone Cabling

Fibre-optic backbone cabling must be labelled on the patch panel at each end identifying the near-end (source) and far-end (destination) cabinet, patch panel and fibre cores. The patch panel schedule must include the near-end and far-end rack, patch panel, core/port, fibre-optic cable type, cable length and connector type.

Example labelling scheme:

In this example there is a 12-core single-mode backbone fibre from the Main Comms Cabinet to the Sub Comms Cabinet A.

Patch panel label [Cabinet] [Patch Panel]

Port label [Cable Type] [Cabinet]-[Patch Panel]-[Port(s)] to [Cabinet]-[Patch Panel]-[Port(s)]

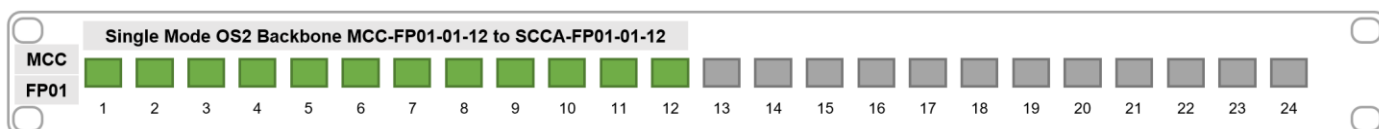

Example backbone patch panel schedule:

Source				Destination				Cable Type	Cable Length
Cabinet	Patch Panel	Core/Port	Connector	Cabinet	Patch Panel	Core/Port	Connector		
MCC	FP01	01	SC/APC	SCC A	FP01	01	SC/APC	SM OS2	400m
MCC	FP01	02	SC/APC	SCC A	FP01	02	SC/APC	SM OS2	400m
MCC	FP01	03	SC/APC	SCC A	FP01	03	SC/APC	SM OS2	400m
...

Fibre-Optic Horizontal Drop Cabling

Fibre-optic horizontal drop cabling must be labelled at each end identifying the near-end (source) and far-end (destination) cabinet, patch panel, zone, and fibre cores. The patch panel schedule must include the near-end and far-end cabinet, patch panel, zone and fibre cores, fibre-optic cable type, cable length and connector type.

Example labelling scheme:

In this example there is 4-core SM drop cable from Sub Comms Cabinet A to Apartment 101 and Apartment 102.

Patch panel labelling at the Sub Comms Cabinet.

Patch panel label [Cabinet] [Patch Panel]

Port label [Apartment]-[Ports]

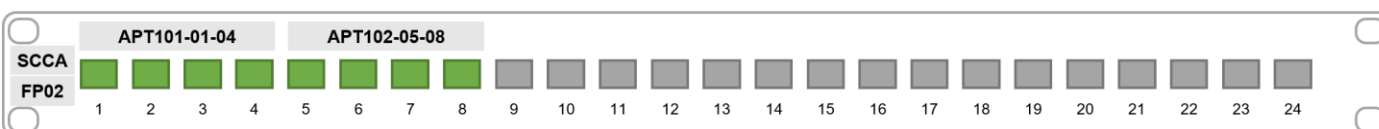

Customer splice point labelling at the Apartment.

Splice point label [Cabinet]-[Patch Panel]-[Ports]

Apartment 101

Apartment 102



Example drop cable patch panel schedule:

Source				Destination			Cable Type	Cable Length
Cabinet	Patch Panel	Core/Port	Connector	Zone	Core/Port	Connector		
SCCA	FP02	01	SC/APC	Apt 101	01	SC/APC	SM OS2	47m
SCCA	FP02	02	SC/APC	Apt 101	02	SC/APC	SM OS2	47m
SCCA	FP02	03	SC/APC	Apt 101	03	SC/APC	SM OS2	47m
SCCA	FP02	04	SC/APC	Apt 101	04	SC/APC	SM OS2	47m
SCCA	FP02	05	SC/APC	Apt 102	01	SC/APC	SM OS2	56m
SCCA	FP02	06	SC/APC	Apt 102	02	SC/APC	SM OS2	56m
SCCA	FP02	07	SC/APC	Apt 102	03	SC/APC	SM OS2	56m
SCCA	FP02	08	SC/APC	Apt 102	04	SC/APC	SM OS2	56m
...

Resident Copper Data Cabling

All resident copper data cabling must be labelled at the RCC quad plate / patch panel with the corresponding data point identification. The labelling/identification scheme must be provided on a 'patch panel schedule' including data point locations and purpose.

Example labelling scheme:

In this example there are 4 copper data cables within the zone numbered sequentially.

Quad plate or patch panel labelling at the Residential Comms Cabinet.

Patch panel label NA

Port label [Port]

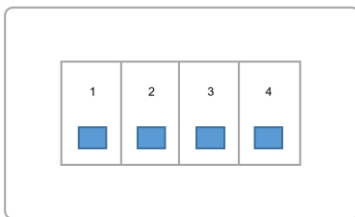

Data point/sockets labelling.

Data point [Port]

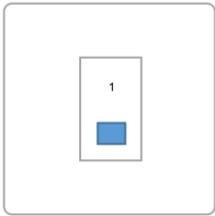

Example apartment copper patch schedule:

Source			Destination				Cable Type	Cable Length
RCC	Port	Connector	Zone	Location	Port	Connector		
Apt 101	01	RJ45	Apt 101	Living room	01	RJ45	Cat6	8m
Apt 101	02	RJ45	Apt 101	Wi-Fi	02	RJ45	Cat6	6m
Apt 101	03	RJ45	Apt 101	Bedroom 1	03	RJ45	Cat6	12m
Apt 101	04	RJ45	Apt 101	Bedroom 2	04	RJ45	Cat6	18m
...

Landlord Copper Data Cabling

Landlord copper data cabling must be labelled at Sub Comms Cabinet (SCC) patch panel and data point with the corresponding data point identification. The labelling/identification scheme must be provided on a 'patch panel schedule' including cabinet, patch panel, port, connector, floor, service area, purpose, cable type and cable length.

Example labelling scheme:

In this example there are 4 copper data cables from the Main Comms Cabinet for Data, Wi-Fi and CCTV connections in the Office, Lobby and Gym areas.

Patch panel labelling at the Sub Comms Cabinet.

Patch panel label [Cabinet] [Patch Panel]

Port label [Port]

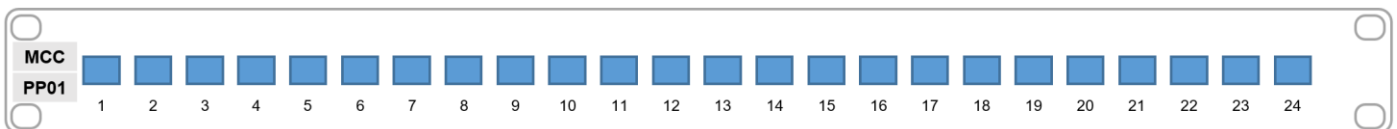

Data point/sockets labelling.

Data point [Cabinet]-[Patch Panel]-[Port]

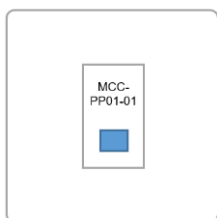

Source				Destination					Cable Type	Cable Length
Cabinet	Patch Panel	Port	Connector	Port ID	Floor	Service Area	Purpose	Connector		
MCC	PP01	01	RJ45	MCC-PP01-01	Ground	Office	Data	RJ45	Cat6	23m
MCC	PP01	02	RJ45	MCC-PP01-02	Ground	Office	Wi-Fi	RJ45	Cat6	18m
MCC	PP01	03	RJ45	MCC-PP01-03	Ground	Lobby	CCTV	RJ45	Cat6	32m
MCC	PP01	04	RJ45	MCC-PP01-04	Ground	Gym	Wi-Fi	RJ45	Cat6	27m
...

APPENDIX 3 – TYPICAL DATA POINT

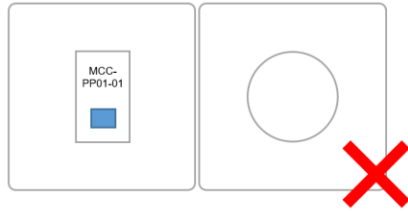
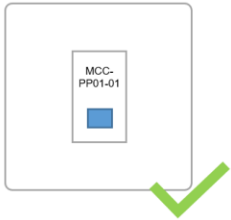
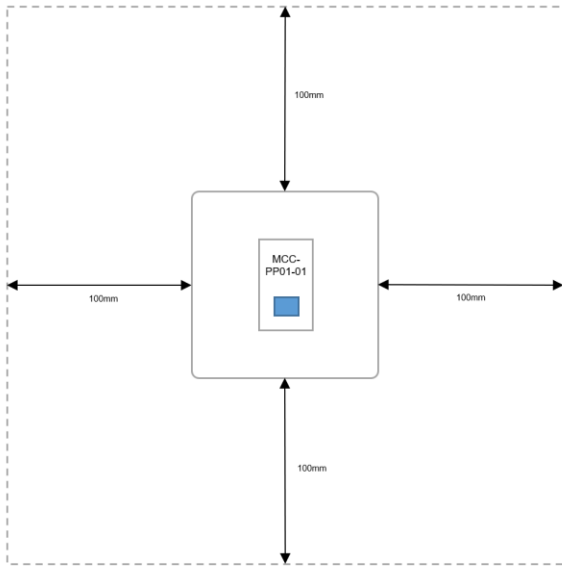

APPENDIX 4 – EXAMPLE COMMS CABINET RACK LAYOUTS

Example 42U Main Comms Cabinet

U42	Fibre-optic backbone cabling	U42	
U41	Cable management bar	U41	
U40	Fibre-optic backbone cabling	U40	
U39	Cable management bar	U39	
U38	Fibre-optic drop cabling	U38	
U37	Fibre-optic drop cabling	U37	
U36	Cable management bar	U36	
U35	Fibre-optic drop cabling	U35	
U34	Fibre-optic drop cabling	U34	
U33	Cable management bar	U33	
U32	Landlord copper data cabling	U32	
U31	Landlord copper data cabling	U31	
U30	Cable management bar	U30	
U29	Space reserved for ASK4	U29	
U28		U28	
U27		U27	
U26		U26	
U25		U25	
U24		U24	
U23		U23	
U22		U22	
U21		U21	
U20		U20	
U19		U19	
U18		U18	
U17		U17	
U16		U16	
U15		U15	
U14		U14	
U13		U13	
U12		U12	
U11		U11	
U10		U10	
U9		U9	
U8		U8	
U7		U7	
U6		U6	
U5		U5	
U4		Telco A	U4
U3		Telco A	U3
U2		Telco B	U2
U1	Telco B	U1	

Example 12U Sub Comms Cabinet

U12	Fibre-optic backbone cabling	U12
U11	Cable management bar	U11
U10	Fibre-optic drop cabling	U10
U9	Fibre-optic drop cabling	U9
U8	Cable management bar	U8
U7	Space reserved for ASK4	U7
U6		U6
U5		U5
U4		U4
U3		U3
U2		U2
U1	PDU	U1

Example 18U Sub Comms Cabinet

U18	Fibre-optic backbone cabling	U18
U17	Cable management bar	U17
U16	Fibre-optic drop cabling	U16
U15	Fibre-optic drop cabling	U15
U14	Cable management bar	U14
U13	Landlord copper data cabling	U13
U12	Landlord copper data cabling	U12
U11	Cable management bar	U11
U10	Space reserved for ASK4	U10
U9		U9
U8		U8
U7		U7
U6		U6
U5		U5
U4		U4
U3		U3
U2	U2	
U1	PDU	U1

Example 24U Sub Comms Cabinet

U24	Fibre-optic backbone cabling	U24
U23	Cable management bar	U23
U22	Fibre-optic drop cabling	U22
U21	Fibre-optic drop cabling	U21
U20	Cable management bar	U20
U19	Fibre-optic drop cabling	U19
U18	Fibre-optic drop cabling	U18
U17	Cable management bar	U17
U16	Landlord copper data cabling	U16
U15	Landlord copper data cabling	U15
U14	Cable management bar	U14
U13	Space reserved for ASK4	U13
U12		U12
U11		U11
U10		U10
U9		U9
U8		U8
U7		U7
U6		U6
U5		U5
U4		U4
U3		U3
U2	U2	
U1	PDU	U1

APPENDIX 5 – RESIDENTIAL COMMS CABINETS

Typical Residential Comms Cabinets compatible with ASK4's Enabling Specification requirements:

AD TEK Products - 2U 19 Low Profile Vertical Wall Mount Network Cabinet 600 Style Light Grey (ADLPC-2U-600-G)

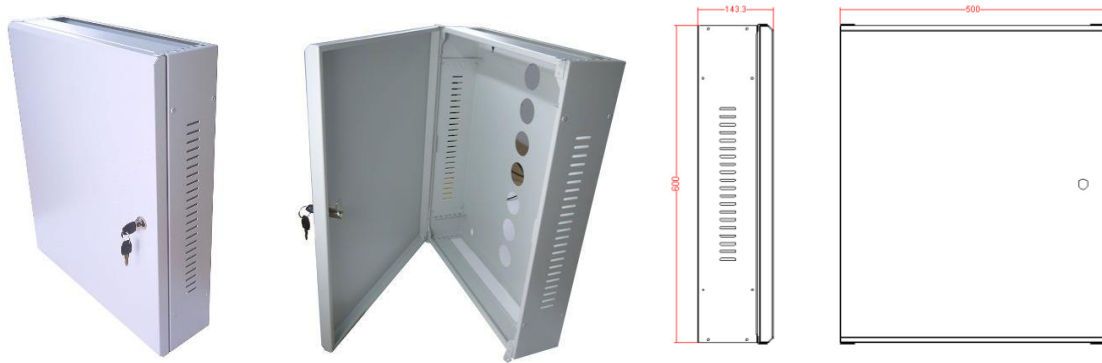

AD TEK Products - 2U 19 Slimline Vertical Wall Mount Network Cabinet Grey (ADSWC2U-G)

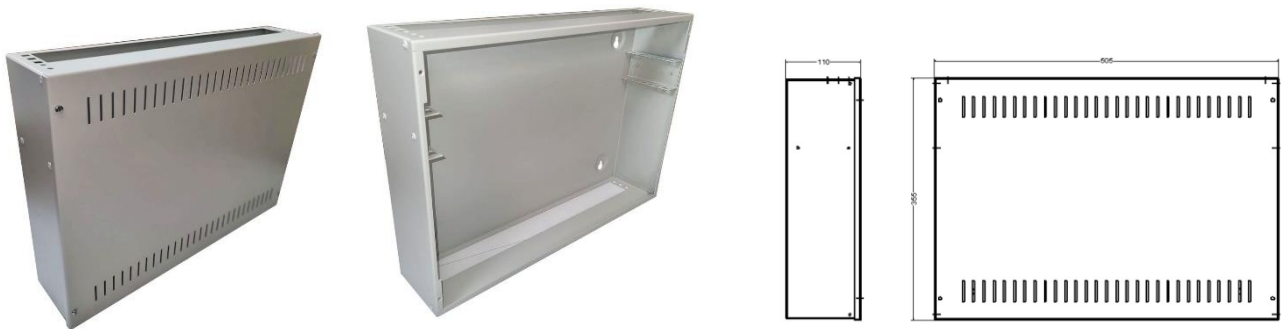

Intellinet Network Solutions - Low-Profile 19" Wall Mount Cabinet with 4U Horizontal and 2U Vertical Rails (713641)

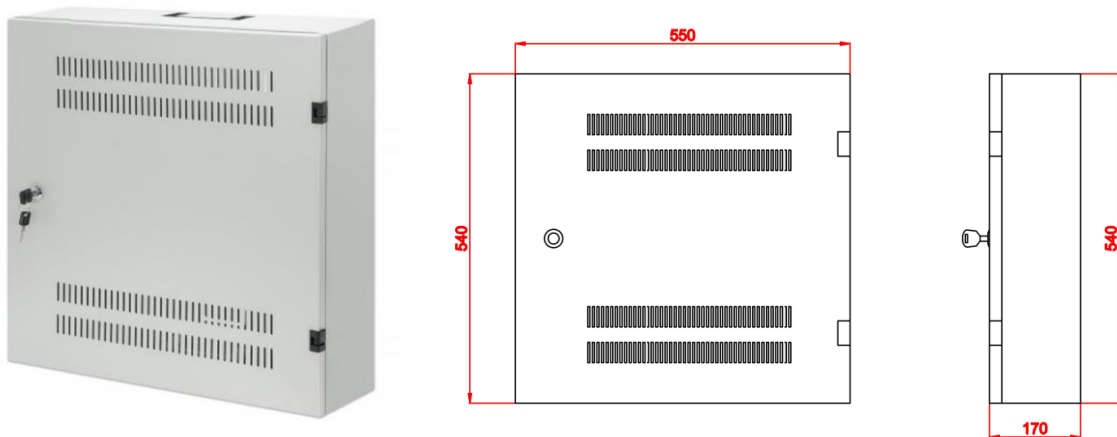

Connectix Cabling Systems - 10u Connectix Home Cabinet (009-000-004-60)



Excel Environ ConSolidation Enclosure Residential Network Cabinet 453mm x 430mm x 160mm Light Grey (100-658)

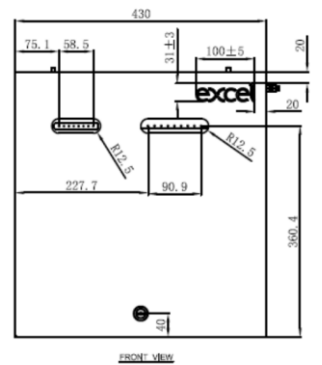
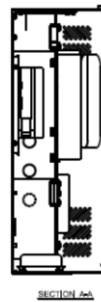
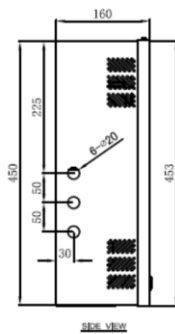

Excel Environ Medium Riser Enclosure Residential Network Cabinet 400mm x 604mm x 125mm Light Grey

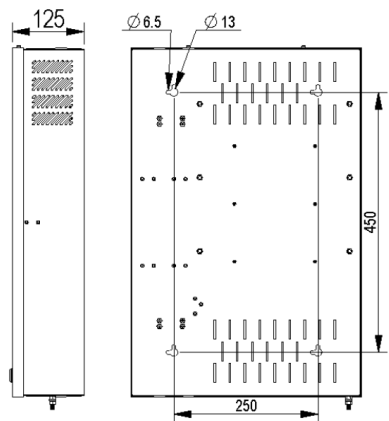
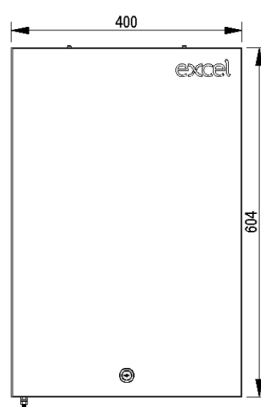
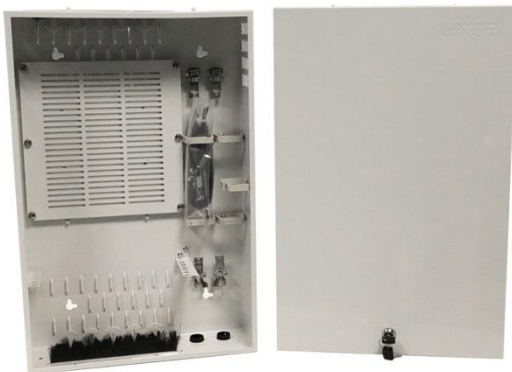

Prysmian Home Hub Box - WM038-08 (w) 400 x (h) 307 x (d) 131



APPENDIX 6 – INFRASTRUCTURE SCHEMATIC FOR ELEVATOR WI-FI

